



Features:

- Compact small 4U chassis
- Supports Intel® 4th/5th Generation Core/Pentium/Celeron Desktop CPUs
- Installs standard ATX motherboards, supports standard 4U power supplies
- Supports up to 7 full-height card slots for expansion, meeting the application needs of various industries
- User-friendly design, with front-mounted system fans that require no tools for maintenance
- Carefully designed tool-free PCIe expansion card holder with higher shock resistance
- Up to 2 optional 3.5-inch shock and impact-resistant hard drive bays
- Front panel USB, power switch design, and power and storage status indicators for easier system maintenance



Remote Management



Status Monitoring



Remote Operations and Maintenance



Security Control

Product Specifications

Model	IPC350-H81	
Processor System	CPU	Support Intel® 4/5th Generation Core / Pentium/ Celeron Desktop CPU
	TDP	95W
	Socket	LGA1150
	Chipset	H81
	BIOS	AMI 256 Mbit SPI
Memory	Socket	2 * Non-ECC U-DIMM Slot, Dual Channel DDR3 up to 1600MHz
	Capacity	16GB, Single Max. 8GB
Graphics	Controller	Intel® UHD Graphics
Ethernet	Controller	1 * Intel i210-AT GbE LAN Chip (10/100/1000 Mbps, RJ45) 1 * Intel i218-LM/V GbE LAN Chip (10/100/1000 Mbps, RJ45)
	Storage	1 * SATA3.0 7P Connector 2 * SATA2.0 7P Connector
Expansion Slots	PCIe	1 * PCIe x16 slot (Gen 3, x16 signal) 1 * PCIe x4 slot (Gen 2, x2 signal, Default, co-lay with Mini PCIe) 1 * PCIe x1 slot (Gen 2, x1 signal)
	PCI	4 * PCI slot
	Mini PCIe	1 * Mini PCIe (PCIe x1 Gen 2 + USB2.0 (Opt., co-lay with PCIe x4 slot), with 1 * SIM Card)
Front I/O	Ethernet	2 * RJ45
	USB	2 * USB3.0 (Type-A) 4 * USB2.0 (Type-A)
	PS/2	1 * PS/2 (Keyboard & Mouse)
	Display	1 * DVI-D: max resolution up to 1920*1200 @ 60Hz 1 * HDMI1.4: max resolution up to 4096*2160 @ 24Hz
	Audio	3 * 3.5mm Jack (Line-out + Line-in + MIC)
	Serial	2 * RS232/422/485 (COM1/2, DB9/M, Full Lanes, BIOS Switch)
Rear I/O	USB	2 * USB2.0 (Type-A)
	Button	1 * Power Button
	LED	1 * Power status LED 1 * Hard drive status LED
Internal I/O	USB	1 * USB2.0 (Vertical TYPE-A)
	COM	4 * RS232 (COM3/4/5/6, Header, Full Lanes)
	Display	1 * VGA: max resolution up to 1920*1200 @ 60Hz (wafer) 1 * eDP: max resolution up to 1920*1200 @ 60Hz (Header)
	Audio	1 * Front Audio (Line-Out + MIC, Header) 1 * Speaker (3W (per channel) into a 4Ω Loads, wafer)
	GPIO	1 * 16 bits DIO (8DI and 8DO, wafer)
	SATA	3 * SATA 7P Connector
	LPT	1 * LPT (Header)
	FAN	2 * SYS FAN (Header) 1 * CPU FAN (Header)
	Power Supply	Type
Power Input Voltage		AC power supply, voltage and frequency shall be based on the ATX power supply provided
RTC Battery		CR2032 Coin Cell
OS Support	Windows	Windows 7/10/11
	Linux	Linux
Watchdog	Output	System Reset
	Interval	Programmable 1 ~ 255 sec
Mechanical	Enclosure Material	SGCC
	Dimensions	330mm(L) * 350mm(W) * 180mm(H)
	Mounting	Wall mounted, Desktop
Environment	Heat Dissipation System	PWM fan cooling
	Operating Temperature	0 ~ 50°C

Storage Temperature	-20 ~ 70°C
Relative Humidity	10 to 90% RH (non-condensing)

Product Dimensions

IPC350立放

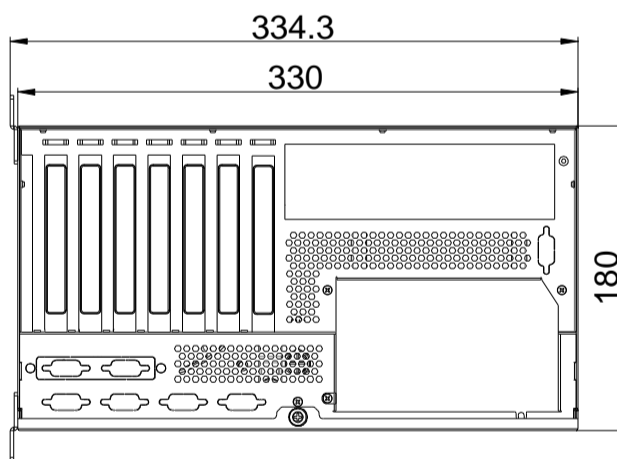
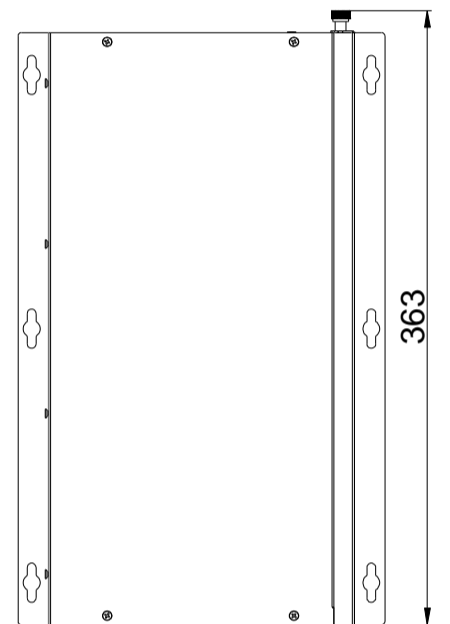
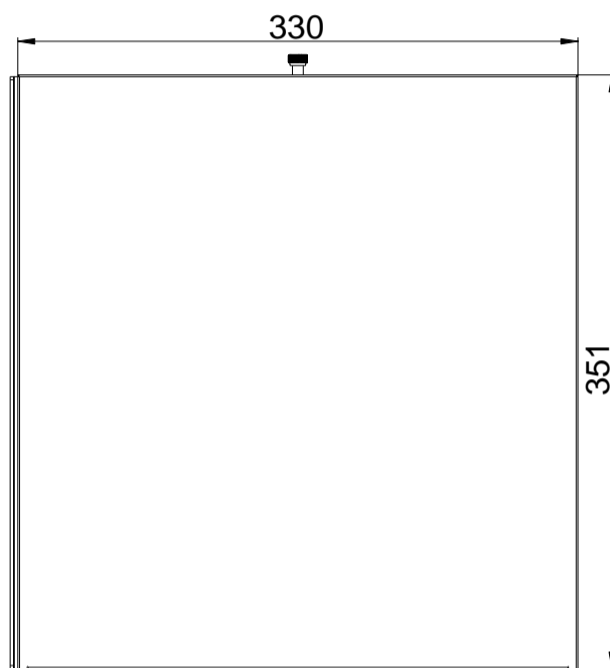
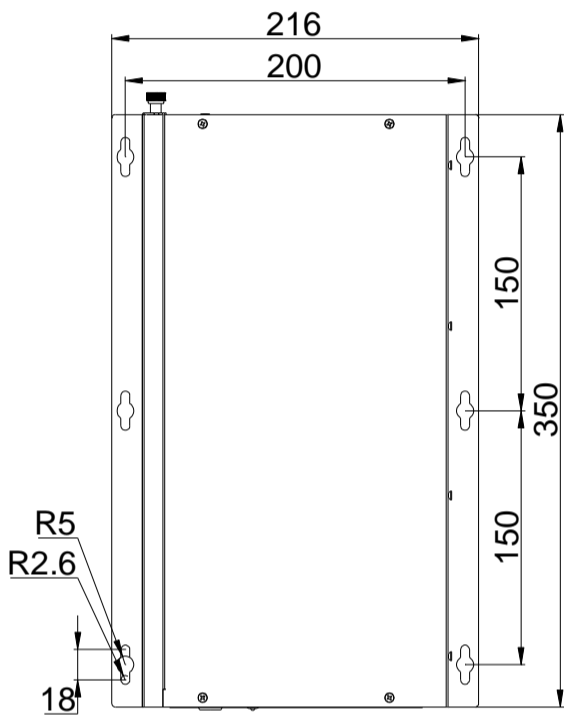
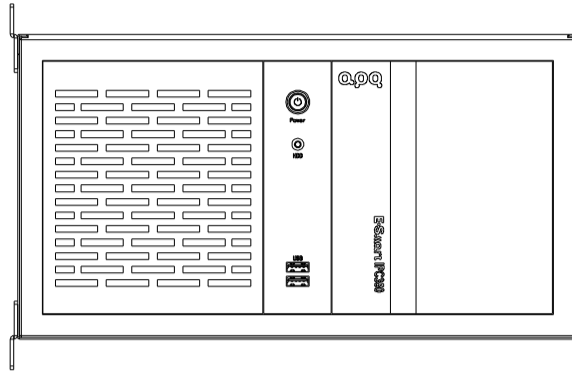

IPC350立放

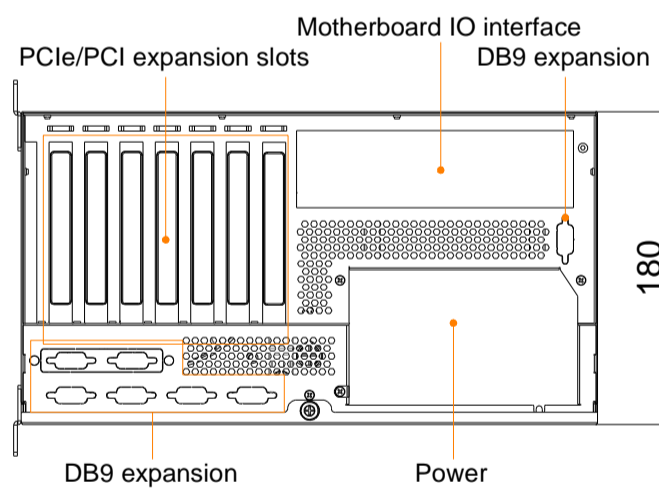
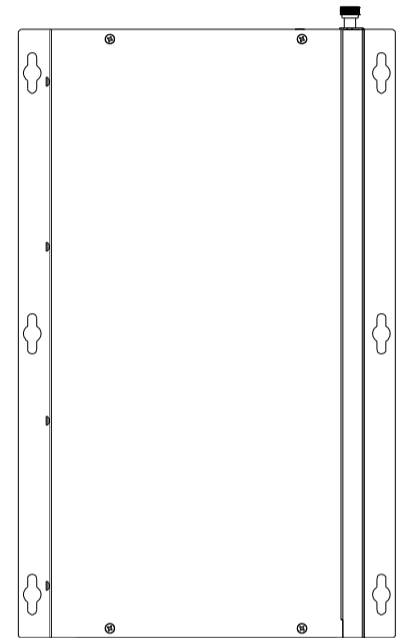
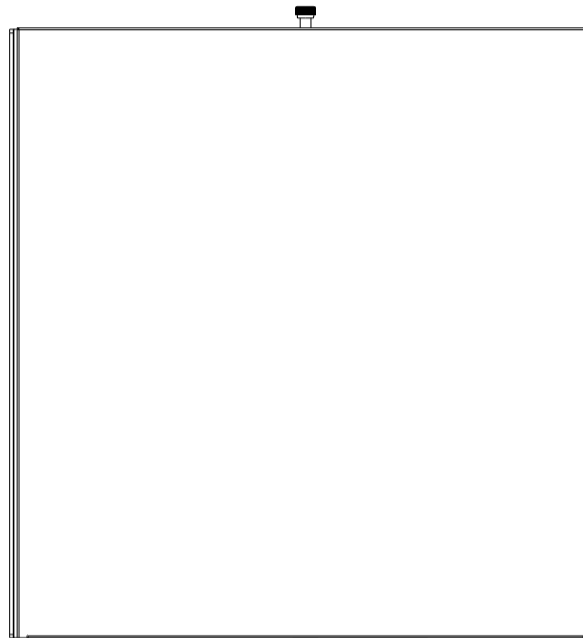
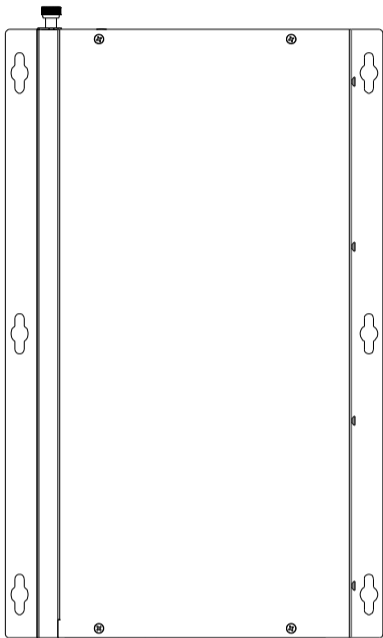
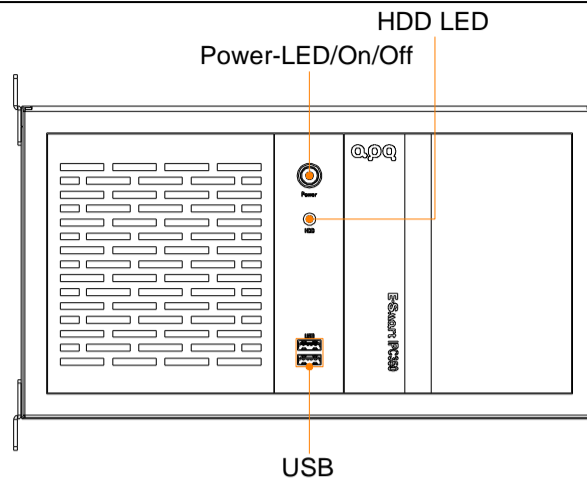

Motherboard Interface

